

# EUROSTEP



TÜV Rheinland  
Genau. Richtig.  
EN14183 Certificate



2025  
CATALOG - KATALOG



## About Us

Çakmak Household Appliances Industry and Limited Company was established in 2004 in a workshop of 400 m<sup>2</sup>. Our company, which started its production life in Kayseri province Türkiye, continues to exist without compromising its principles. Our company, which plays a leading role in the sector, manufactures metal household stairs. Çakmak Household Appliances has been opened to the world with its patented Eurostep brand. Eurostep is the brand name of our metal household ladders.

Our company has adopted the principle of bringing unique and high quality products to the market and has always cared about customer satisfaction. Our company carries out production by means of modern and technological machines in our factory with an open area of 20.000 m<sup>2</sup> and closed area of 12.000 m<sup>2</sup>. Qualified manpower is also used during the manufacture of our products. Our professional and qualified team conducts R & D studies with great decisiveness and contributes to our product range.

Çakmak Ev Gereçleri Sanayi ve Ticaret Limited Şirketi delivers 20% of its products to the Turkish domestic market and 80% to foreign markets. Our company, which has managed to deliver our products to 37 countries, will grow day by day with its dynamic staff in the globalizing, renewing and changing world and will increase its monthly production capacity of 50,000 units to 100,000 units in 2025 with its new investments.

## Hakkımızda

Çakmak Ev Gereçleri Sanayi ve Ticaret Limited Şirketi, 2004 yılında 400 m<sup>2</sup>'lik bir atölyede kurulmuştur. Türkiye'nin Kayseri ilinde üretim hayatına başlayan firmamız, ilkelerinden taviz vermeden varlığını sürdürmektedir.

Sektöründe öncü rol gösteren firmamız, metal ev tipi merdiven üretimi gerçekleştirmektedir. Çakmak Ev Gereçleri, tescilli Eurostep markasıyla dünyaya açılmıştır.

Eurostep, metal ev tipi merdivenlerimizin marka ismidir. Firmamız benzersiz ve kaliteli ürünleri piyasa ile buluşturmayı ilke edinmiş, müşteri memnuniyetini her daim önemsemiştir.

Firmamız, 20.000 m<sup>2</sup> açık alan ve 12.000 m<sup>2</sup> kapalı alana sahiptir. Fabrikamızda modern ve teknolojik makineler vasıtasıyla üretim gerçekleştirilmektedir. Ürünlerimizin imalatı sırasında nitelikli insan gücünden de yararlanılmaktadır. Profesyonel ve nitelikli ekibimiz, Ar- Ge çalışmalarını büyük bir titizlikle yürütmekte, ürün yelpazemize katkıda bulunmaktadır.

Çakmak Ev Gereçleri Sanayi ve Ticaret Limited Şirketi ürünlerinin %20'sini Türkiye iç pazarına %80'ini yurtdışı pazarlarına ulaştırmaktadır. Ürünlerimizi 37 ülkeye ulaştırmayı başarmış olan firmamız küreselleşen, yenilenen ve değişen dünyada, dinamik kadrosuyla günden güne büyüyerek aylık 50.000 adetlik üretim kapasitesini 2025 yılında yeni yatırımları ile 100.000 adete çıkaracaktır.

# INDEX (İÇİNDEKİLER)

Eurotower .....	01-02
Eurotower Plus.....	03-04
Eurotower Plus Assembled .....	05-06
Minitower .....	07-08
Minitower Plus .....	09-10
Mensa Plus .....	11-12
Anka .....	13-14
Anka Plus.....	15-16
Leo .....	17-18
Leo Plus .....	19-20
Lepus .....	21-22
Lepus Plus .....	23-24
Vera .....	25-26
Vera Plus .....	27-28
Certificates .....	29-30

# CAKMAK

EV GEREÇLERİ SANAYİ VE TİCARET LTD.ŞTİ.

## Eurotower

STEEL STEP STOOL LADDER



TÜVRheinland®  
EN 14183 Certificate

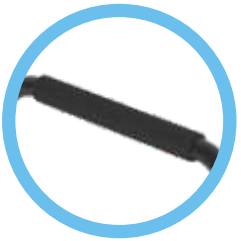

1 Practical Foam Hand Grip  
Pratik Sünger El Tutma Yeri



2 Ergonomic Carrying Compartment  
Ergonomik Taşıma Bölmesi

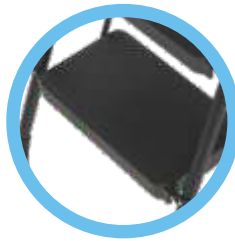

3 Wide Anti - Slip Plastic Step  
Geniş Kaymaz Plastik Basamak



4 Support Additional Profile  
Ek Destek Profili



5 Non Slip Plastic Foot  
Kaymaz Plastik Ayak

EUROSTEP

### 1 - STEP

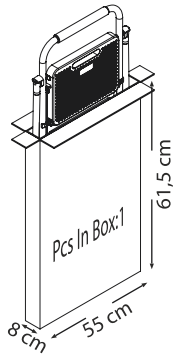

181001T

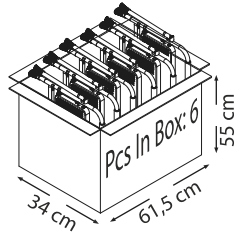

181001

### 2 - STEP

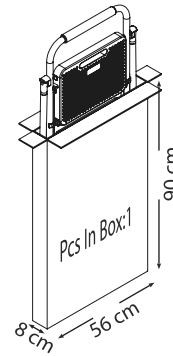

182001T

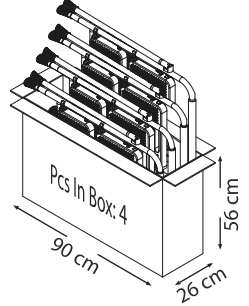

182001

TÜVRheinland®  
Genau. Richtig.  
EN 14183 Certificate

### 3 - STEP

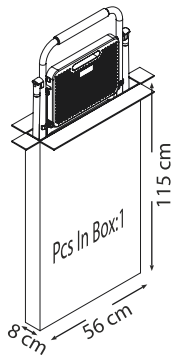

183001T

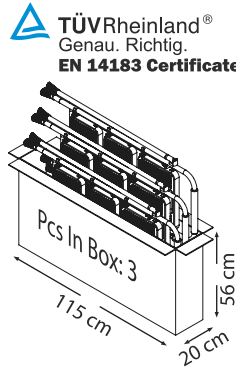

183001

TÜVRheinland®  
Genau. Richtig.  
EN 14183 Certificate

### 4 - STEP

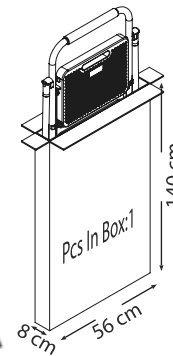

184002T

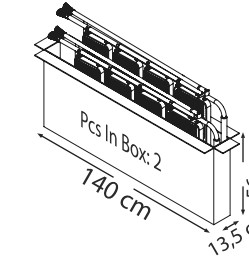

184002

### 4 - STEP-EU

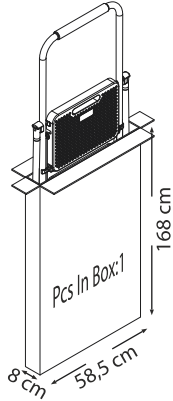

184001T

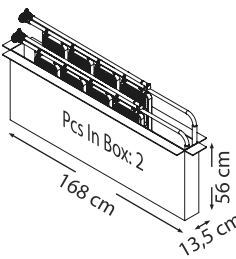

184001

TÜVRheinland®  
Genau. Richtig.  
EN 14183 Certificate

### 5 - STEP

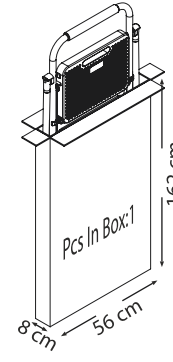

185001T

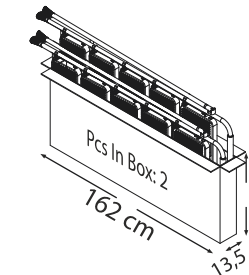

185001

### TECHNICAL INFORMATION



MODEL NAME	CODE	PIECES IN BOX (Pcs. - Adt.)	WEIGHT (± 0,50 Kg)	CBM(m <sup>3</sup> )	20 DC (33 m <sup>3</sup> ) (Pcs.-Adt.)	40 HQ (76 m <sup>3</sup> ) (Pcs.-Adt.)	TRUCK (90 m <sup>3</sup> ) (Pcs.-Adt.)
1 - Step / Basamak Single	181001T	1	3,45	0,027	1220	2810	3330
1 - Step / Basamak Multiple	181001	6	18,35	0,123	1608	3702	4386
2 - Step / Basamak Single	182001T	1	5,26	0,044	750	1727	2090
2 - Step / Basamak Multiple	182001	4	19,70	0,134	984	2268	2744
3 - Step / Basamak Single	183001T	1	7,27	0,054	611	1407	1703
3 - Step / Basamak Multiple	183001	3	20,27	0,135	732	1686	2043
4 - Step / Basamak Single	184002T	1	9,10	0,066	500	1151	1393
4 - Step / Basamak Multiple	184002	2	17,22	0,106	622	1432	1734
4 - Step / Basamak Single EU	184001T	1	9,25	0,086	383	883	1069
4 - Step / Basamak Single EU	184001	2	18,00	0,134	492	1134	1372
5 - Step / Basamak Single	185001T	1	9,50	0,086	380	880	1045
5 - Step / Basamak Multiple	185001	2	20,00	0,134	490	1130	1340

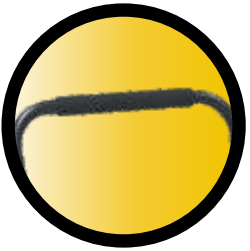

1 Practical Foam Hand Grip  
Pratik Tutma Yeri



2 Ergonomic Carrying Compartment  
Ergonomik Taşıma Bölmesi



3 With Tool Tray  
Alet Tepsisi



4 Wide Anti - Slip Plastic Step  
Kaymayı Önleyen Plastik  
Basamak



5 Non - Slip Plastic Foot  
Kaymaz Plastik Ayak

### 3 - STEP + TOOL TRAY

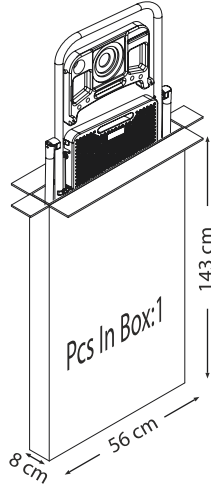

183005T



183005

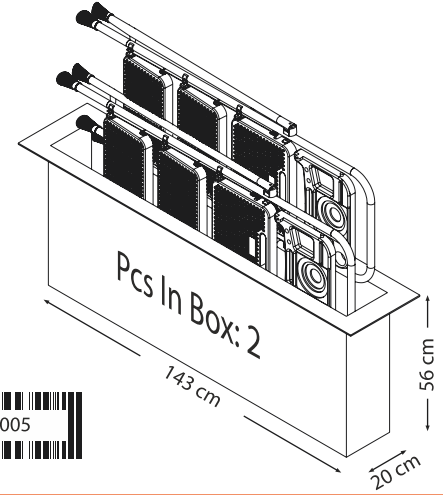

### 4 - STEP + TOOL TRAY

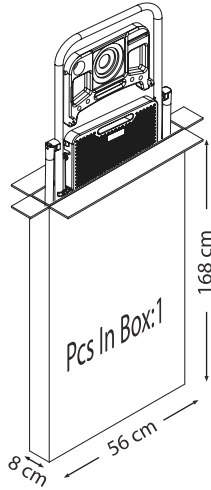

184005T



184005

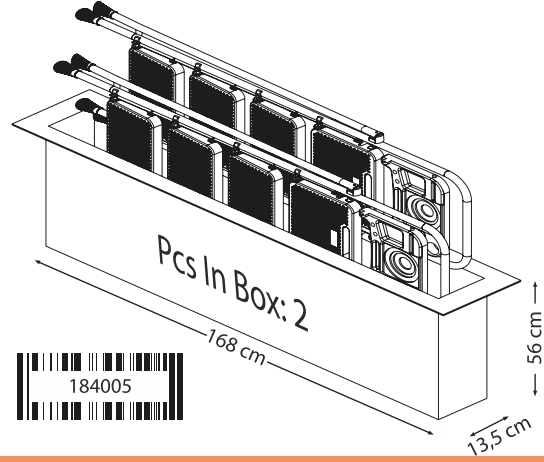

### 5 - STEP + TOOL TRAY

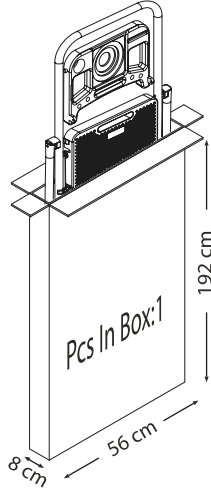

185005T



185005

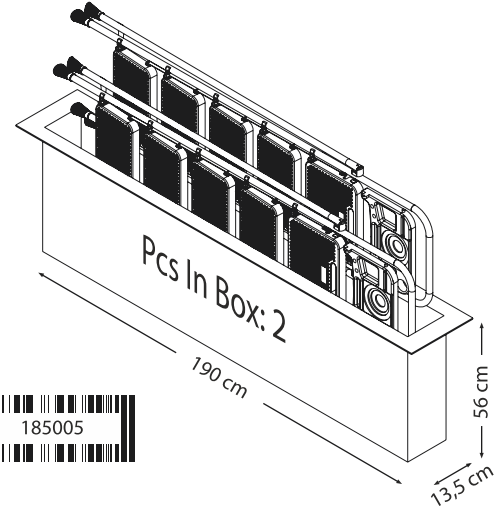

### TECHNICAL INFORMATION

MODEL NAME	CODE	PIECES IN BOX (Pcs. - Adt.)	WEIGHT (± 0,50 Kg)	CBM (m <sup>3</sup> )	20 DC (33 m <sup>3</sup> ) (Pcs. - Adt.)	40 HQ (76 m <sup>3</sup> ) (Pcs. - Adt.)	TRUCK (90 m <sup>3</sup> ) (Pcs. - Adt.)
3 - Step / Basamak Single	183005T	1	8,00	0,067	490	1130	1340
3 - Step / Basamak Multiple	183005	2	22,40	0,168	580	1350	1600
4 - Step / Basamak Single	184005T	1	9,80	0,086	380	880	1040
4 - Step / Basamak Multiple	184005	2	19,00	0,134	490	1130	1340
5 - Step / Basamak Single	185005T	1	11,20	0,090	360	840	1000
5 - Step / Basamak Multiple	185005	2	21,60	0,150	440	1010	1200



1 Practical Foam Hand Grip  
Pratik Tutma Yeri



2 Ergonomic Carrying Compartment  
Ergonomik Taşıma Bölmesi

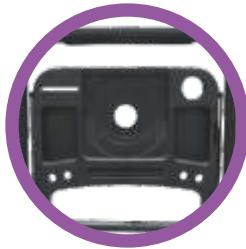

3 With Tool Tray  
Alet Tepsisi



4 Wide Anti - Slip Plastic Step  
Kaymayı Önleyen Plastik  
Basamak



5 Non - Slip Plastic Foot  
Kaymaz Plastik Ayak



# Eurotower Plus Assembled

## STEEL STEP STOOL LADDER



EV GEREÇLERİ SANAYİ VE TİCARET LTD. ŞTİ.

### 3 - STEP + TOOL TRAY

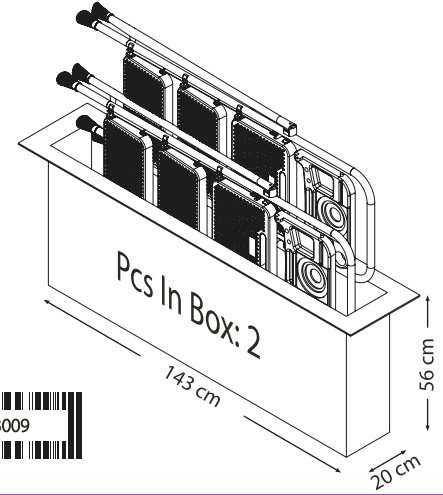
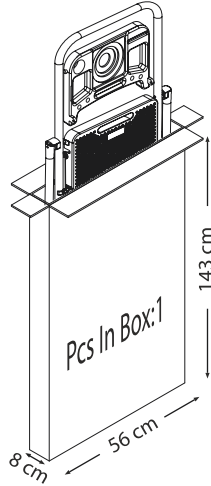

### 4 - STEP + TOOL TRAY

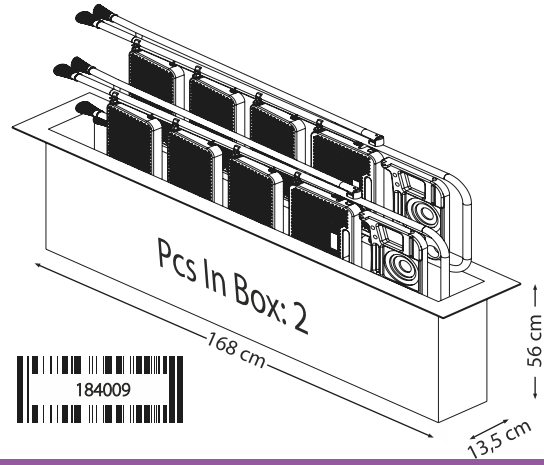
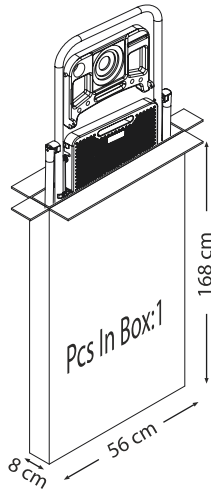

### 5 - STEP + TOOL TRAY

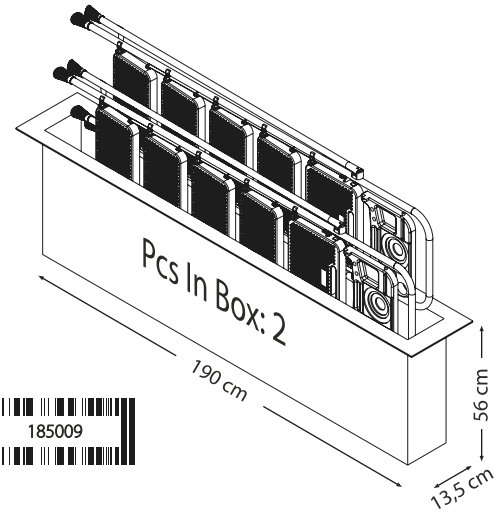
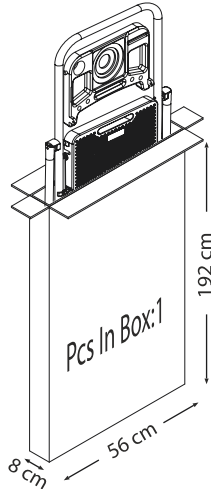

### TECHNICAL INFORMATION

MODEL NAME	CODE	PIECES IN BOX (Pcs. - Adt.)	WEIGHT (± 0,50 Kg)	CBM (m <sup>3</sup> )	20 DC (33 m <sup>3</sup> ) (Pcs. - Adt.)	40 HQ (76 m <sup>3</sup> ) (Pcs. - Adt.)	TRUCK (90 m <sup>3</sup> ) (Pcs. - Adt.)
3 - Step / Basamak Single	183009T	1	8,00	0,067	490	1130	1340
3 - Step / Basamak Multiple	183009	2	22,40	0,168	580	1350	1600
4 - Step / Basamak Single	184009T	1	9,80	0,086	380	880	1040
4 - Step / Basamak Multiple	184009	2	19,00	0,134	490	1130	1340
5 - Step / Basamak Single	185009T	1	11,20	0,090	360	840	1000
5 - Step / Basamak Multiple	185009	2	21,60	0,150	440	1010	1200

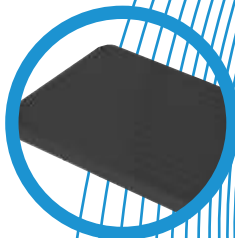
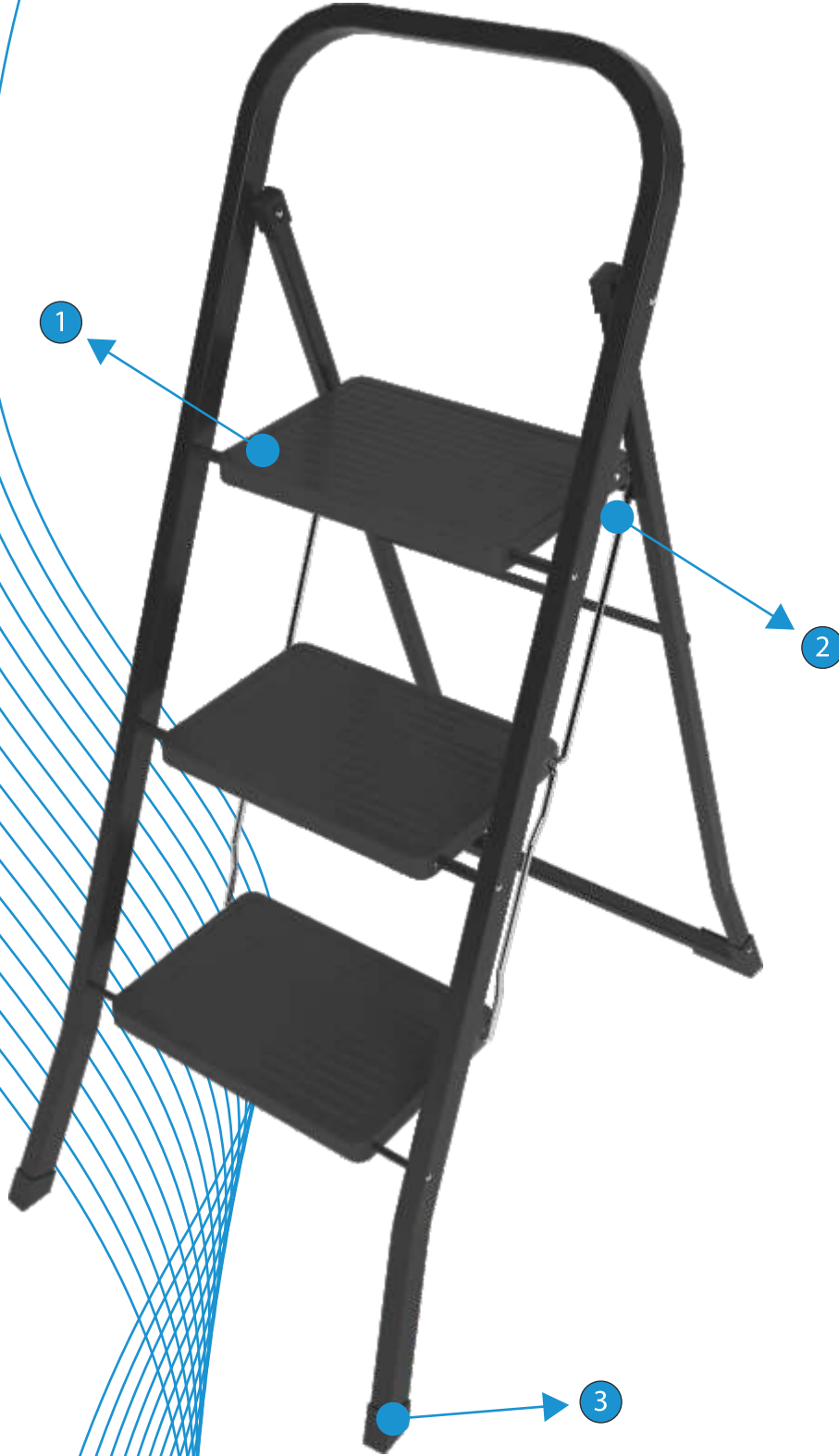

1 **Wide Anti - Slip Metal Step**  
Geniş - Kaymaz Metal Basamak



2 **Safety Lock**  
Güvenlik Kiliti

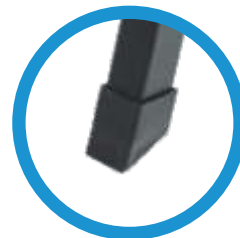

3 **Non Slip Plastic Foot**  
Kaymaz Plastik Ayak

### 2 - STEP

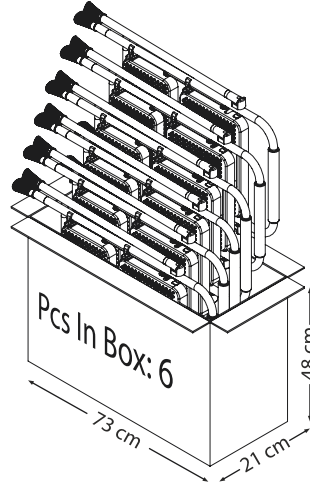

### 3 - STEP

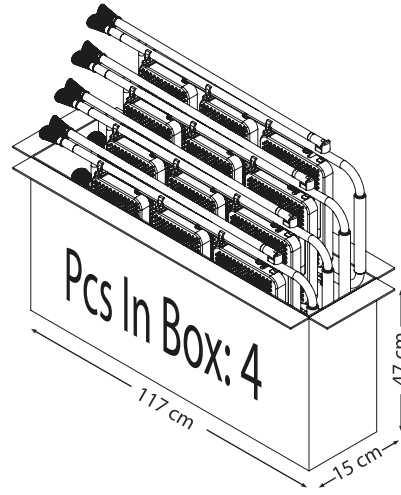
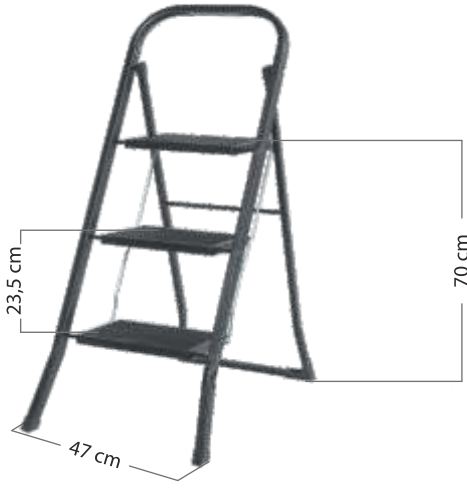

### 4 - STEP

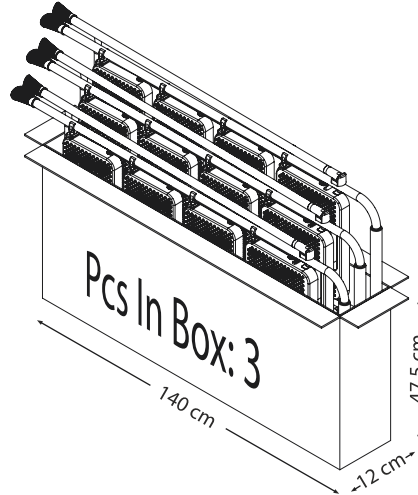
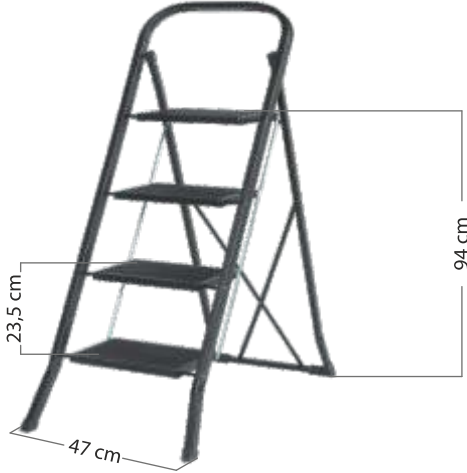

### TECHNICAL INFORMATION

MODEL NAME	CODE	PIECES IN BOX (Pcs. - Adt.)	WEIGHT (± 0,50 Kg)	CBM (m <sup>3</sup> )	20 DC (33 m <sup>3</sup> ) (Pcs. - Adt.)	40 HQ (76 m <sup>3</sup> ) (Pcs. - Adt.)	TRUCK (90 m <sup>3</sup> ) (Pcs. - Adt.)
2 - Step / Basamak	19502	6	26,27	0,098	2016	4650	5628
3 - Step / Basamak	19503	4	24,35	0,090	1464	3376	4088
4 - Step / Basamak	19504	3	24,37	0,096	1029	2373	2874



1 **Wide Anti - Slip Plastic Step**  
Geniş - Kaymaz Plastik Basamak



2 **Safety Lock**  
Güvenlik Kiliti

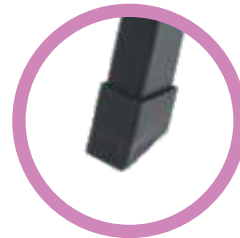

3 **Non Slip Plastic Foot**  
Kaymaz Plastik Ayak

# Minitower Plus

## STEEL STEP STOOL LADDER



EV GEREÇLERİ SANAYİ VE TİCARET LTD. ŞTİ.

### 2 - STEP

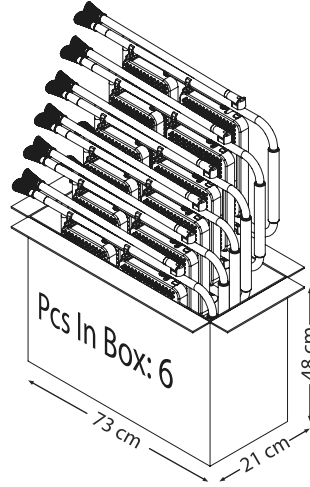

19002

### 3 - STEP

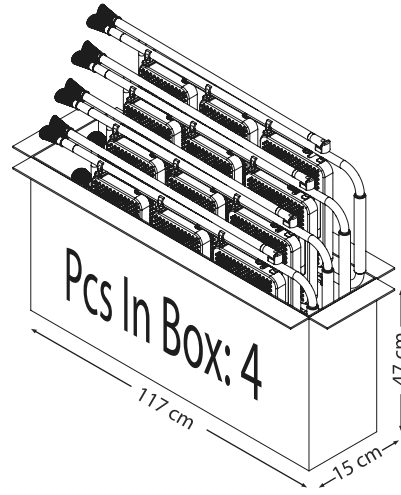
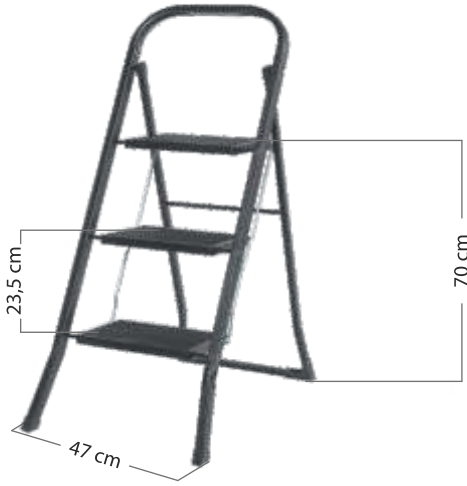

19003

### 4 - STEP

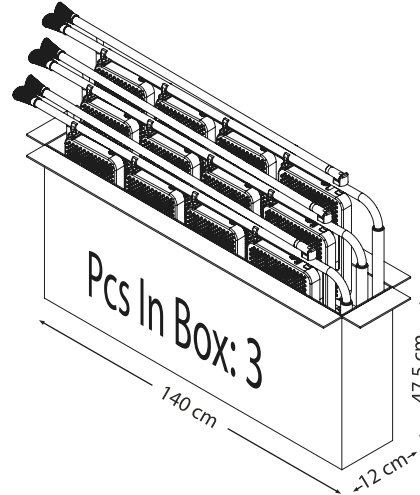
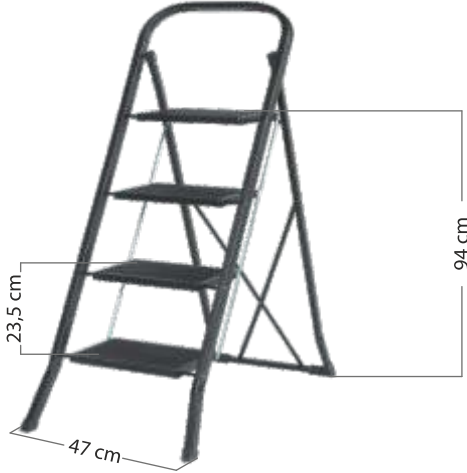

19004

### TECHNICAL INFORMATION

MODEL NAME	CODE	PIECES IN BOX (Pcs. - Adt.)	WEIGHT (± 0,50 Kg)	CBM (m <sup>3</sup> )	20 DC (33 m <sup>3</sup> ) (Pcs. - Adt.)	40 HQ (76 m <sup>3</sup> ) (Pcs. - Adt.)	TRUCK (90 m <sup>3</sup> ) (Pcs. - Adt.)
2 - Step / Basamak	19002	6	26,27	0,098	2016	4650	5628
3 - Step / Basamak	19003	4	24,35	0,090	1464	3376	4088
4 - Step / Basamak	19004	3	24,37	0,096	1029	2373	2874

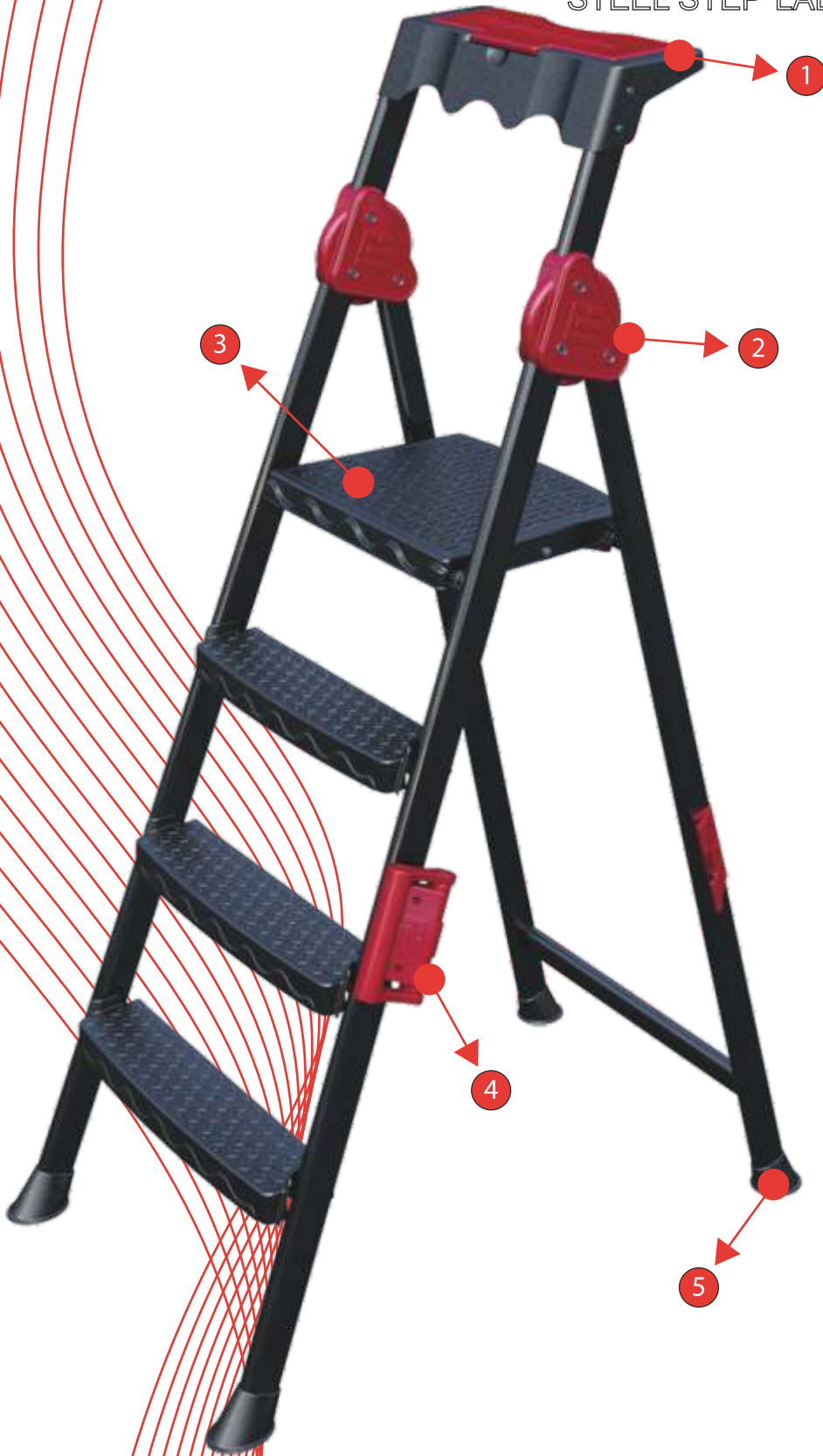

1 Multi Purpose Top Cap  
Çok Amaçlı Üst Tepelik



2 Plastic Hinge System  
Plastik Mentеше Sistemi

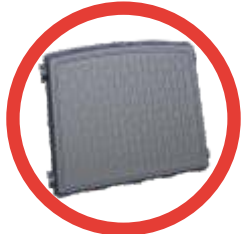

3 Plastic Large Top Table  
Geniş Üst Tabla



4 Carrying Handle  
Taşıma Kulpu



5 Non Slip Plastic Foot  
Kaymaz Plastik Ayak

3 - STEP

2+1



14003

4 - STEP

3+1



14004

5 - STEP

4+1



14005

6 - STEP

5+1



14006

7 - STEP

6+1



14007

8 - STEP

7+1



14008

9 - STEP

8+1

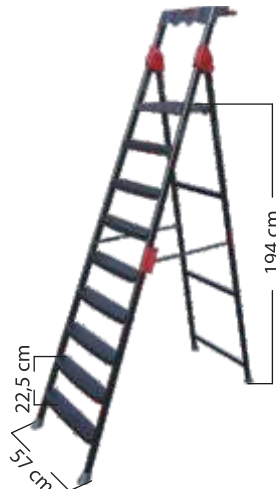

14009

10 - STEP

9+1

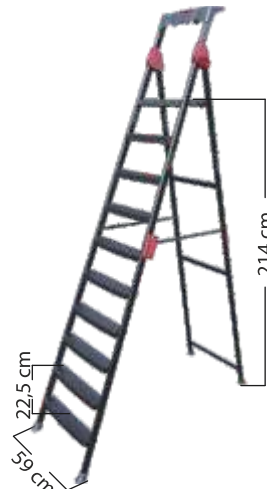

14010

### TECHNICAL INFORMATION

MODEL NAME	CODE	WEIGHT (± 0,50 Kg)	CBM (m <sup>3</sup> )	20 DC (33 m <sup>3</sup> ) (Pcs. - Adt.)	40 HQ (76 m <sup>3</sup> ) (Pcs. - Adt.)	TRUCK (90 m <sup>3</sup> ) (Pcs. - Adt.)
3 - Step / Basamak (2+1)	14003	5,45	0,076	434	1000	1210
4 - Step / Basamak (3+1)	14004	6,52	0,091	362	835	1010
5 - Step / Basamak (4+1)	14005	7,63	0,102	323	745	901
6 - Step / Basamak (5+1)	14006	8,78	0,118	279	644	779
7 - Step / Basamak (6+1)	14007	9,62	0,135	244	562	681
8 - Step / Basamak (7+1)	14008	11,14	0,151	218	503	609
9 - Step / Basamak (8+1)	14009	12,40	0,167	197	455	550
10 - Step / Basamak (9+1)	14010	13,73	0,183	180	415	502



1 Special Top Cap  
Özel Üst Tepelik



2 Strong Connection Part  
Sağlam Bağlantı Elemanı



3 Anti Skidding Plastic Top Table  
Kaymaz Üst Tabla Plastik



4 Special D Profile Step  
Özel D Profil Basamak



5 Non Slip Plastic Foot  
Kaymaz Plastik Ayak



**3 - STEP**

**2+1**

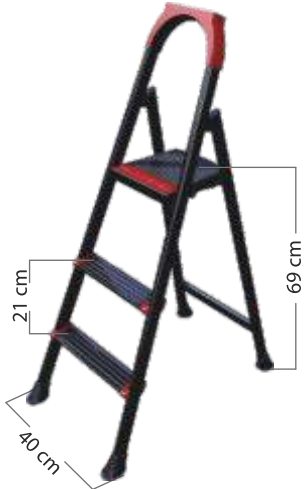

10003

**4 - STEP**

**3+1**



10004

**5 - STEP**

**4+1**



10005

**6 - STEP**

**5+1**



10006

**7 - STEP**

**6+1**



10007

**8 - STEP**

**7+1**



10008

**9 - STEP**

**8+1**



10009

**10 - STEP**

**9+1**



10010

### TECHNICAL INFORMATION

MODEL NAME	CODE	WEIGHT (± 0,50 Kg)	CBM (m <sup>3</sup> )	20 DC (33 m <sup>3</sup> ) (Pcs. - Adt.)	40 HQ (76 m <sup>3</sup> ) (Pcs. - Adt.)	TRUCK (90 m <sup>3</sup> ) (Pcs. - Adt.)
3 - Step / Basamak (2+1)	10003	4,35	0,049	673	1551	1877
4 - Step / Basamak (3+1)	10004	5,32	0,061	540	1245	1508
5 - Step / Basamak (4+1)	10005	6,29	0,073	452	1041	1260
6 - Step / Basamak (5+1)	10006	7,31	0,084	392	904	1095
7 - Step / Basamak (6+1)	10007	8,26	0,100	330	760	920
8 - Step / Basamak (7+1)	10008	10,00	0,122	270	622	754
9 - Step / Basamak (8+1)	10009	10,93	0,134	246	567	686
10 - Step / Basamak (9+1)	10010	12,16	0,146	226	520	630



1 Special Top Cap  
Özel Üst Tepelik

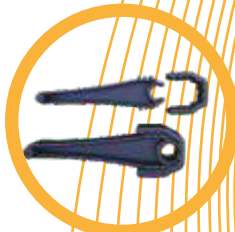

2 Strong Connection Part  
Sağlam Bağlantı Elemanı



3 Anti Skidding Plastic Top Table  
Kaymaz Üst Tabla Plastiği



4 Carrying Handle  
Taşıma Kulpu



5 Non Slip Plastic Foot  
Kaymaz Plastik Ayak

## STEEL STEP LADDER

3 - STEP

2+1



12003

4 - STEP

3+1



12004

5 - STEP

4+1



12005

6 - STEP

5+1



12006

7 - STEP

6+1



12007

8 - STEP

7+1



12008

9 - STEP

8+1



12009

### TECHNICAL INFORMATION

MODEL NAME	CODE	WEIGHT (± 0,50 Kg)	CBM (m <sup>3</sup> )	20 DC (33 m <sup>3</sup> ) (Pcs. - Adt.)	40 HQ (76 m <sup>3</sup> ) (Pcs. - Adt.)	TRUCK (90 m <sup>3</sup> ) (Pcs. - Adt.)
3 - Step / Basamak (2+1)	12003	4,39	0,050	660	1520	1840
4 - Step / Basamak (3+1)	12004	5,62	0,062	532	1225	1483
5 - Step / Basamak (4+1)	12005	6,37	0,074	445	1027	1243
6 - Step / Basamak (5+1)	12006	7,27	0,085	388	894	1082
7 - Step / Basamak (6+1)	12007	8,51	0,101	326	752	910
8 - Step / Basamak (7+1)	12008	9,92	0,124	266	612	741
9 - Step / Basamak (8+1)	12009	11,05	0,136	242	558	676



1 Special Top Cap  
Özel Üst Tepelik

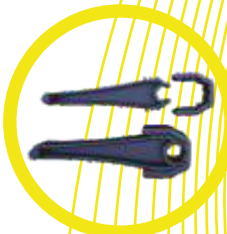

2 Strong Connection Part  
Sağlam Bağlantı Elemanı



3 Anti Skidding Plastic Top Table  
Kaymaz Üst Tabla Plastiği



4 Special D Profile Step  
Özel D Profil Basamak



5 Non Slip Plastic Foot  
Kaymaz Plastik Ayak

## STEEL STEP LADDER

3 - STEP

2+1



11003

4 - STEP

3+1



11004

5 - STEP

4+1



11005

6 - STEP

5+1

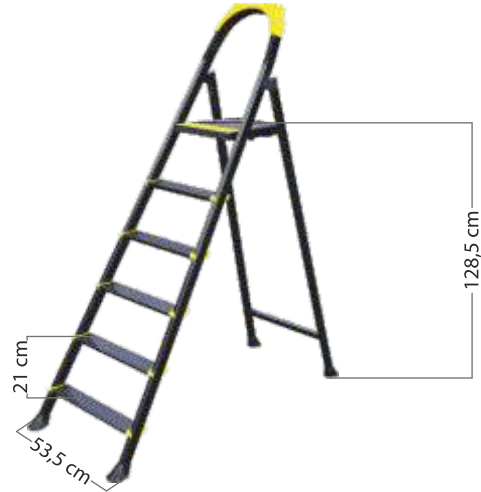

11006

7 - STEP

6+1

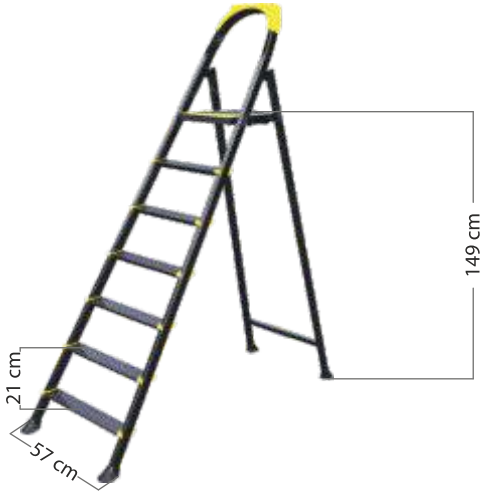

11007

8 - STEP

7+1

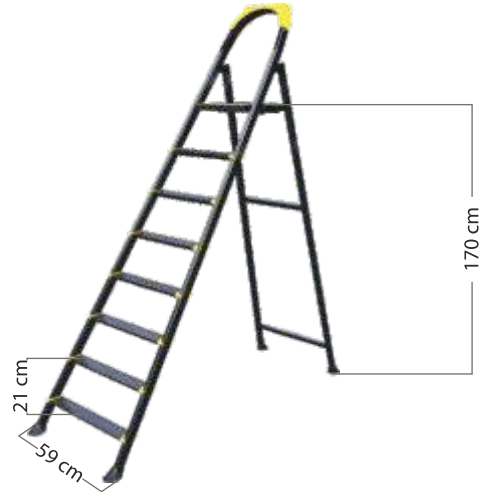

11008

### TECHNICAL INFORMATION

MODEL NAME	CODE	WEIGHT (± 0,50 Kg)	CBM (m <sup>3</sup> )	20 DC (33 m <sup>3</sup> ) (Pcs. - Adt.)	40 HQ (76 m <sup>3</sup> ) (Pcs. - Adt.)	TRUCK (90 m <sup>3</sup> ) (Pcs. - Adt.)
3 - Step / Basamak (2+1)	11003	3,70	0,044	750	1727	2090
4 - Step / Basamak (3+1)	11004	4,43	0,054	611	1407	1703
5 - Step / Basamak (4+1)	11005	5,34	0,065	507	1169	1415
6 - Step / Basamak (5+1)	11006	6,02	0,077	428	987	1194
7 - Step / Basamak (6+1)	11007	6,95	0,090	366	844	1022
8 - Step / Basamak (7+1)	11008	7,95	0,104	317	730	884

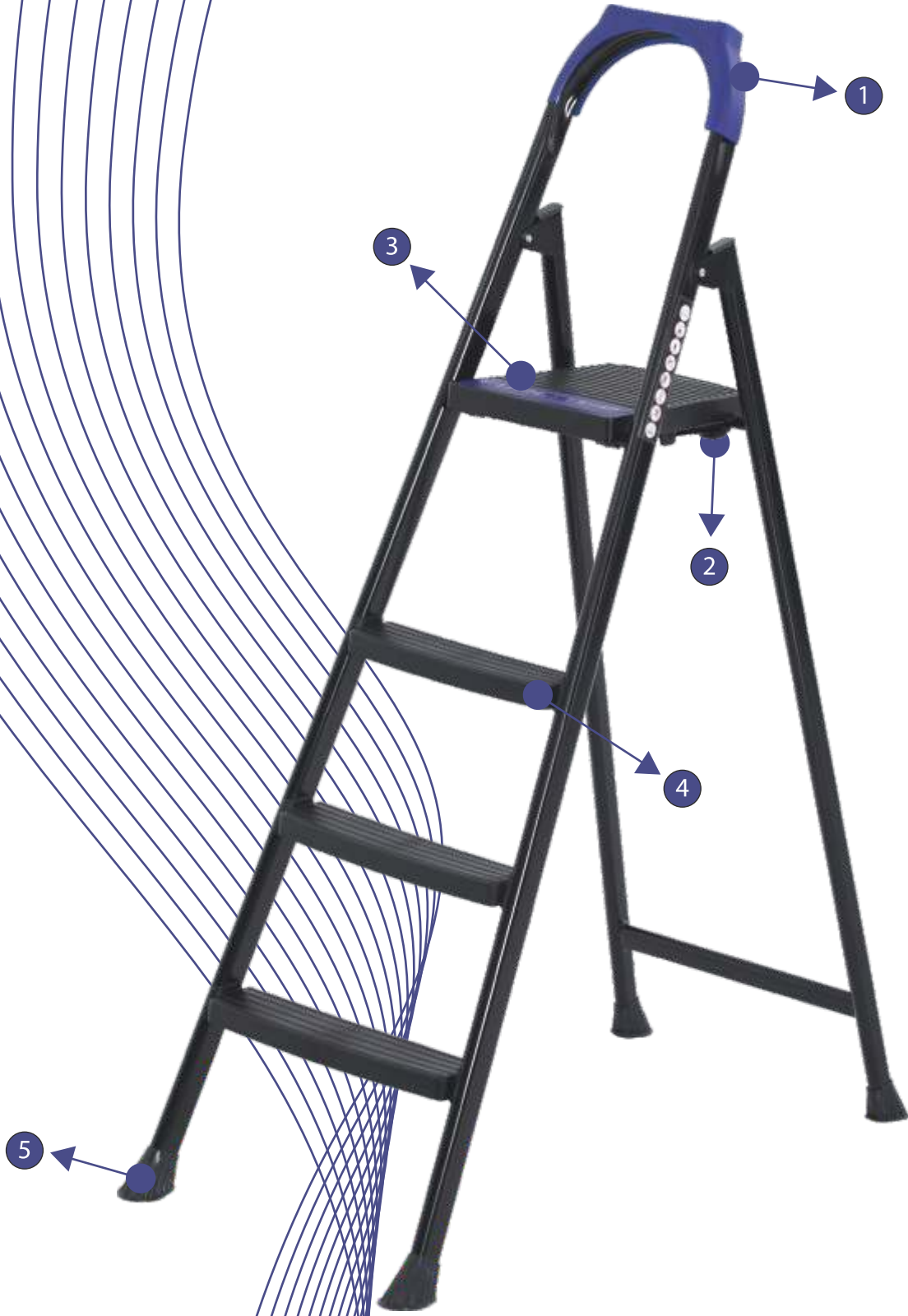

5

4

2

3

1

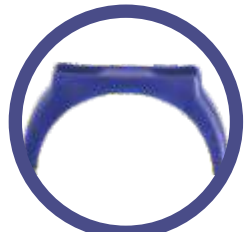

1 Special Top Cap  
Özel Üst Tepelik



2 Strong Connection Part  
Sağlam Bağlantı Elemanı



3 Anti Skidding Plastic Top Table  
Kaymaz Üst Tabla Plastiği



4 Special Plastic Step  
Özel Plastik Basamak



5 Non Slip Plastic Foot  
Kaymaz Plastik Ayak

### 3 - STEP

2+1



17003

### 4 - STEP

3+1

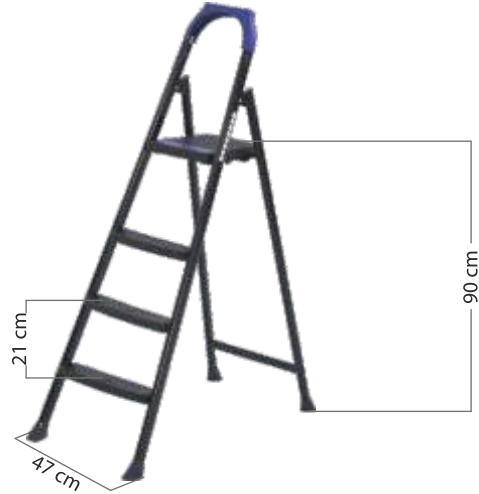

17004

### 5 - STEP

4+1



17005

### 6 - STEP

5+1



17006

### 7 - STEP

6+1

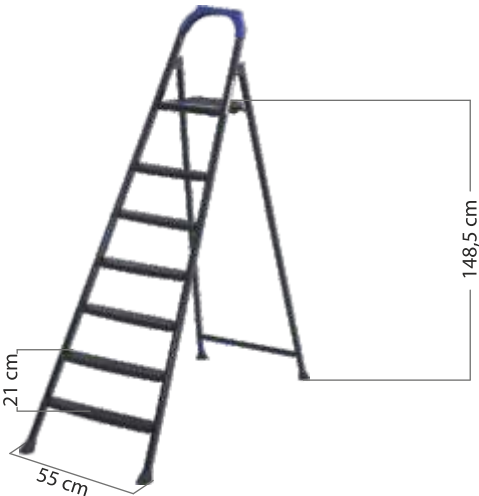

17007

### 8 - STEP

7+1

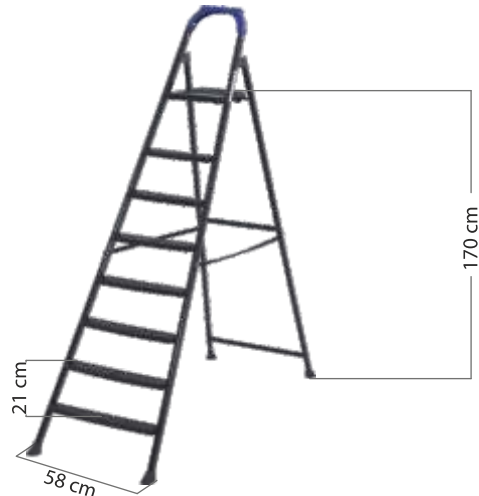

17008

### TECHNICAL INFORMATION

MODEL NAME	CODE	WEIGHT (± 0,50 Kg)	CBM (m <sup>3</sup> )	20 DC (33 m <sup>3</sup> ) (Pcs. - Adt.)	40 HQ (76 m <sup>3</sup> ) (Pcs. - Adt.)	TRUCK (90 m <sup>3</sup> ) (Pcs. - Adt.)
3 - Step / Basamak (2+1)	17003	3,75	0,045	733	1688	2044
4 - Step / Basamak (3+1)	17004	4,42	0,054	611	1407	1703
5 - Step / Basamak (4+1)	17005	5,19	0,065	507	1169	1415
6 - Step / Basamak (5+1)	17006	5,95	0,076	434	1000	1210
7 - Step / Basamak (6+1)	17007	6,70	0,090	366	844	1022
8 - Step / Basamak (7+1)	17008	7,97	0,102	323	745	901



1 Plastic Hinge System  
Plastik Mentşe Sistemi

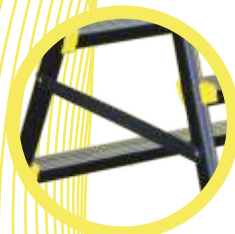

2 Safety Belt  
Güvenlik Kayışı

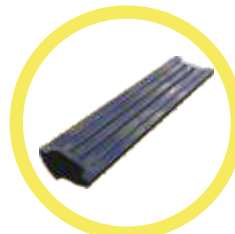

3 Special D Profile Step  
Özel D Profil Basamak



4 Non Slip Plastic Foot  
Kaymaz Plastik Ayak



### 2 + 2 - STEP



### 3 + 3 - STEP



### 4 + 4 - STEP



### 5 + 5 - STEP



### 6 + 6 - STEP



### 7 + 7 - STEP



### TECHNICAL INFORMATION

MODEL NAME	CODE	WEIGHT (± 0,50 Kg)	CBM (m <sup>3</sup> )	20 DC (33 m <sup>3</sup> ) (Pcs. - Adt.)	40 HQ (76 m <sup>3</sup> ) (Pcs. - Adt.)	TRUCK (90 m <sup>3</sup> ) (Pcs. - Adt.)
2 + 2 Step / Basamak	15002	2,57	0,032	1031	2375	2875
3 + 3 Step / Basamak	15003	3,70	0,045	733	1688	2044
4 + 4 Step / Basamak	15004	4,75	0,059	559	1288	1559
5 + 5 Step / Basamak	15005	5,83	0,073	452	1041	1260
6 + 6 Step / Basamak	15006	7,19	0,087	379	873	1057
7 + 7 Step / Basamak	15007	8,30	0,102	323	745	901

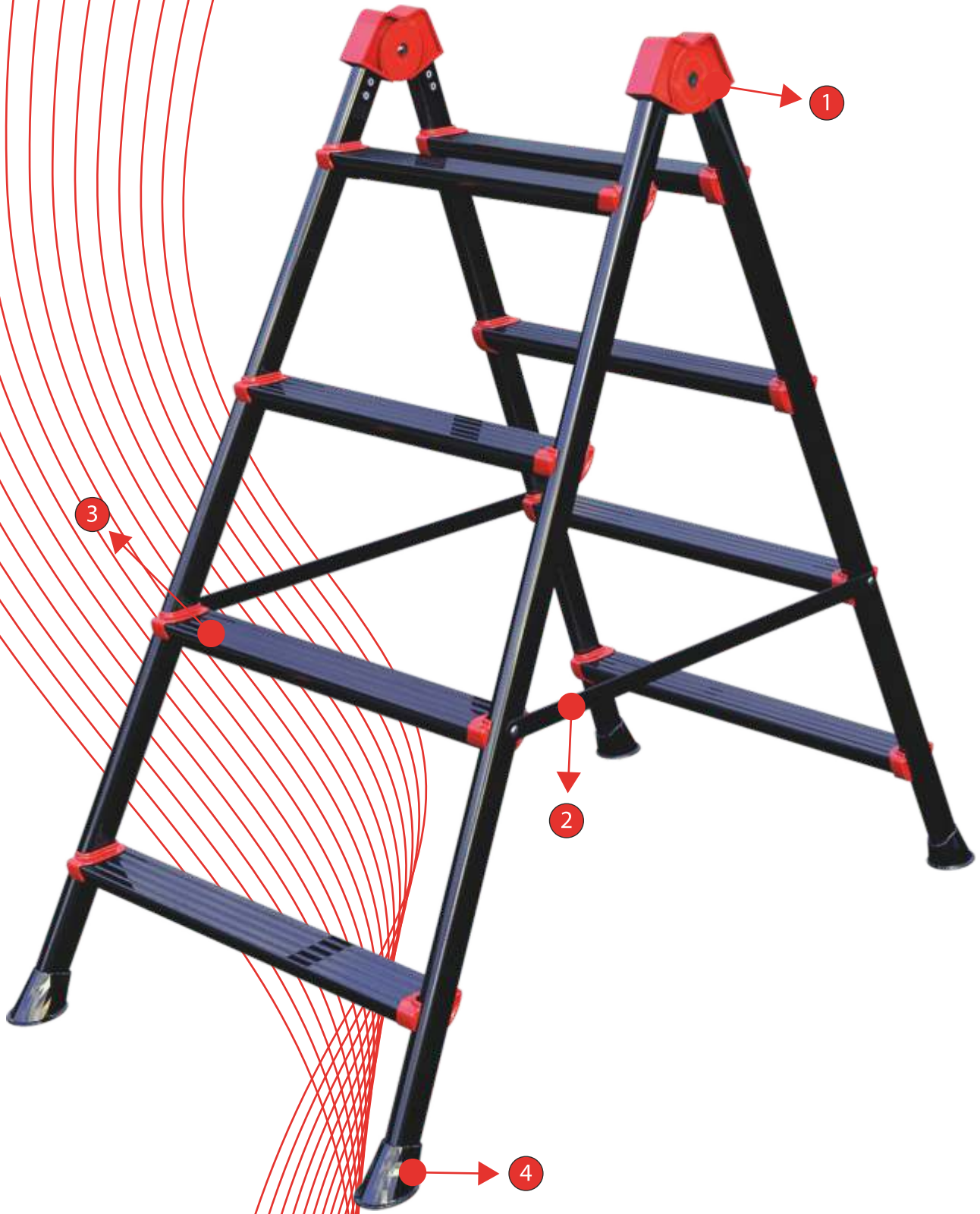

1 Plastic Hinge System  
Plastik Mentеше Sistemi



2 Safety Belt  
Güvenlik Kayışı

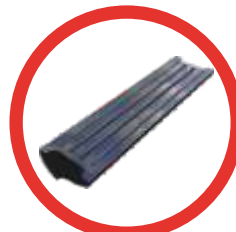

3 Special D Profile Step  
Özel D Profil Basamak



4 Non Slip Plastic Foot  
Kaymaz Plastik Ayak

### 2 + 2 - STEP



16002

### 3 + 3 - STEP



16003

### 4 + 4 - STEP



16004

### 5 + 5 - STEP



16005

### 6 + 6 - STEP



16006

### 7 + 7 - STEP

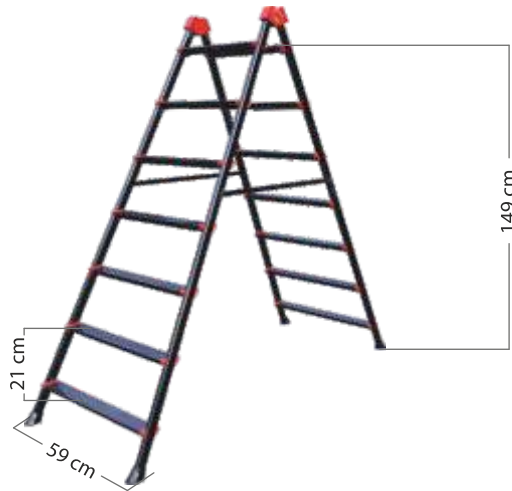

16007

### TECHNICAL INFORMATION

MODEL NAME	CODE	WEIGHT (± 0,50 Kg)	CBM (m <sup>3</sup> )	20 DC (33 m <sup>3</sup> ) (Pcs. - Adt.)	40 HQ (76 m <sup>3</sup> ) (Pcs. - Adt.)	TRUCK (90 m <sup>3</sup> ) (Pcs. - Adt.)
2 + 2 Step / Basamak	16002	3,30	0,035	942	2171	2628
3 + 3 Step / Basamak	16003	4,60	0,048	687	1583	1916
4 + 4 Step / Basamak	16004	6,00	0,063	526	1212	1467
5 + 5 Step / Basamak	16005	7,51	0,078	425	980	1187
6 + 6 Step / Basamak	16006	9,25	0,093	354	817	989
7 + 7 Step / Basamak	16007	10,70	0,112	294	678	821



1 Slim Design  
İnce Tasarım



2 Strong Connection Part  
Sağlam Bağlantı Elemanı



3 Anti Skidding Plastic Top Table  
Kaymaz Üst Tabla Plastik



4 Special D Profile Step  
Özel D Profil Basamak



5 Non Slip Plastic Foot  
Kaymaz Plastik Ayak

## STEEL STEP LADDER

3 - STEP

2+1



20003

4 - STEP

3+1

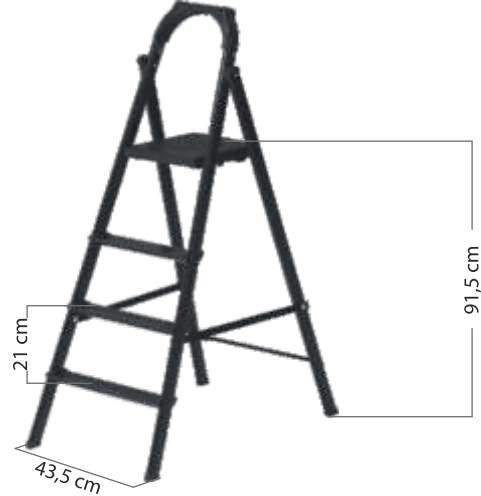

20004

5 - STEP

4+1

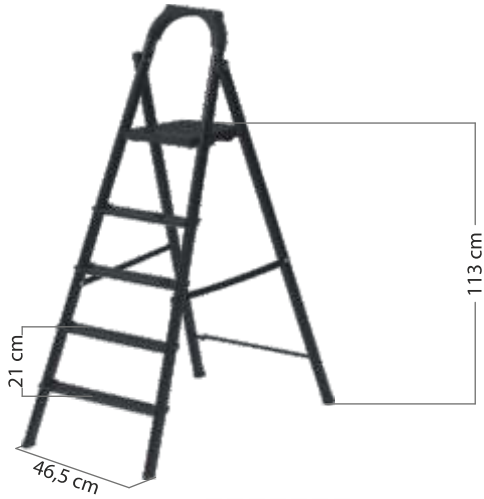

20005

6 - STEP

5+1

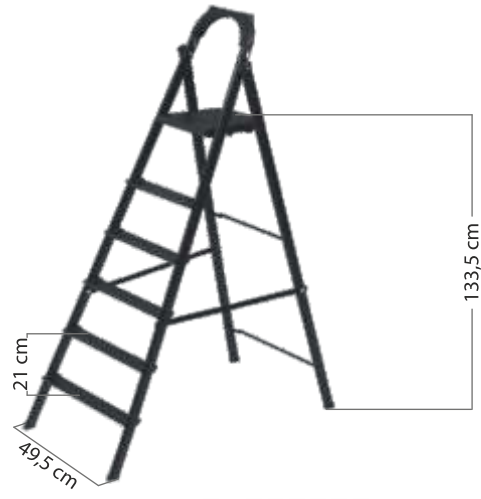

20006

7 - STEP

6+1

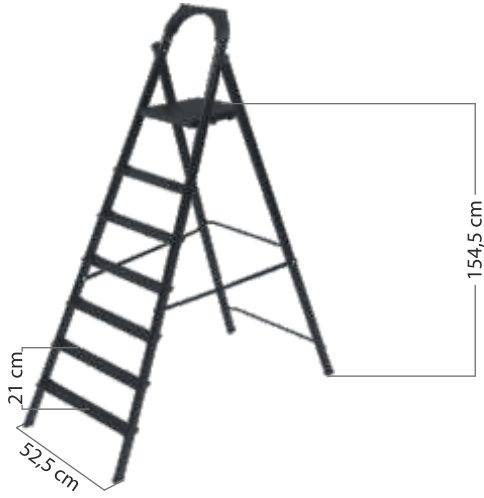

20007

8 - STEP

7+1

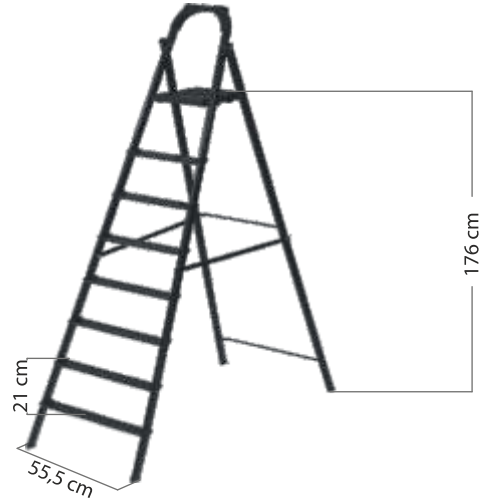

20008

### TECHNICAL INFORMATION

MODEL NAME	CODE	WEIGHT (± 0,50 Kg)	CBM (m <sup>3</sup> )	20 DC (33 m <sup>3</sup> ) (Pcs. - Adt.)	40 HQ (76 m <sup>3</sup> ) (Pcs. - Adt.)	TRUCK (90 m <sup>3</sup> ) (Pcs. - Adt.)
3 - Step / Basamak (2+1)	20003	3,84	0,040	750	1727	2045
4 - Step / Basamak (3+1)	20004	4,61	0,054	611	1407	1667
5 - Step / Basamak (4+1)	20005	5,38	0,065	508	1169	1385
6 - Step / Basamak (5+1)	20006	6,40	0,077	429	987	1169
7 - Step / Basamak (6+1)	20007	7,51	0,090	367	844	1000
8 - Step / Basamak (7+1)	20008	8,13	0,104	317	731	865

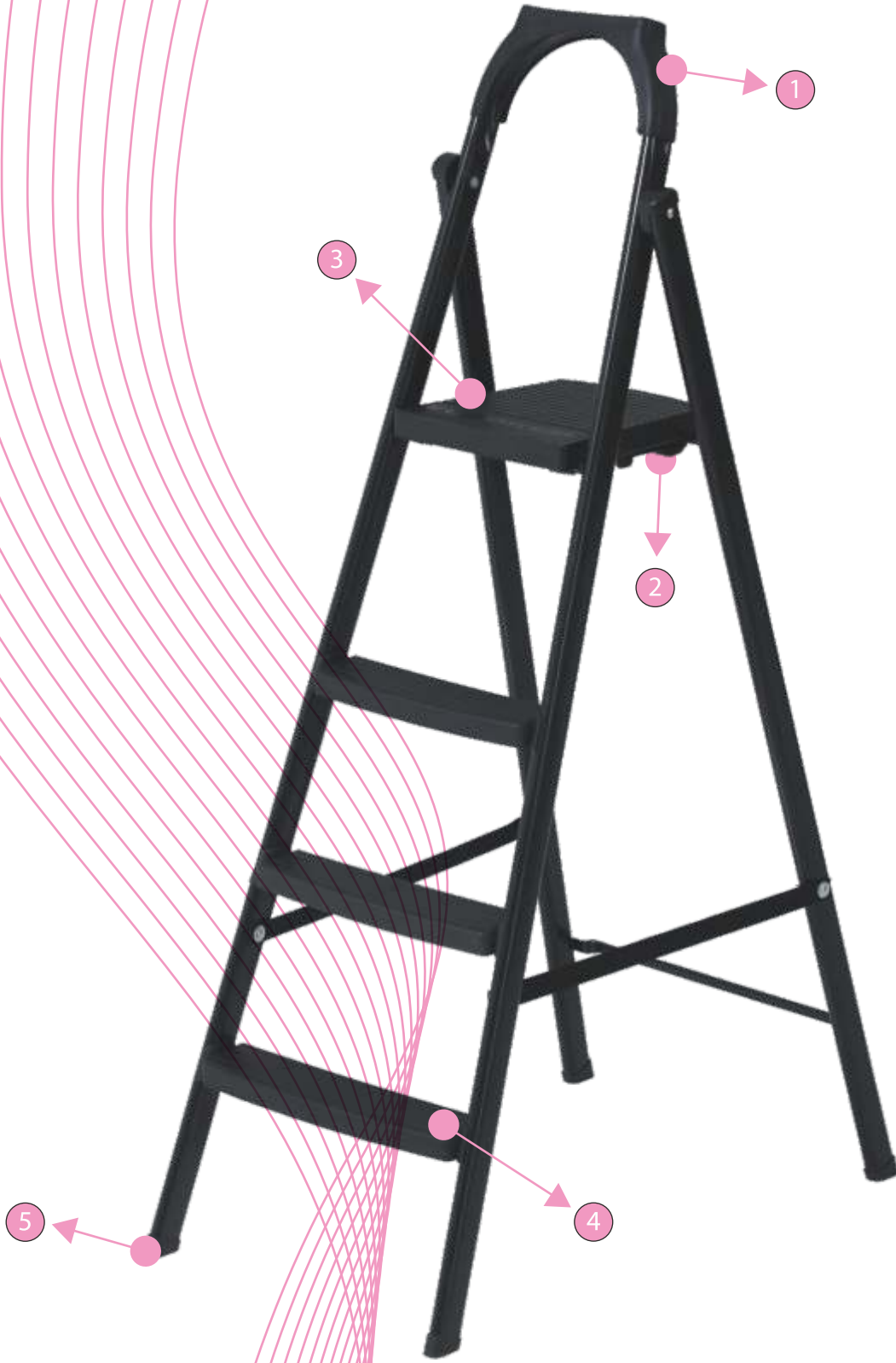

1 Slim Design  
İnce Tasarım



2 Strong Connection Part  
Sağlam Bağlantı Elemanı



3 Anti Skidding Plastic Top Table  
Kaymaz Üst Tabla Plastiği



4 Special D Profile Step  
Özel D Profil Basamak



5 Non Slip Plastic Foot  
Kaymaz Plastik Ayak

3 - STEP

2+1

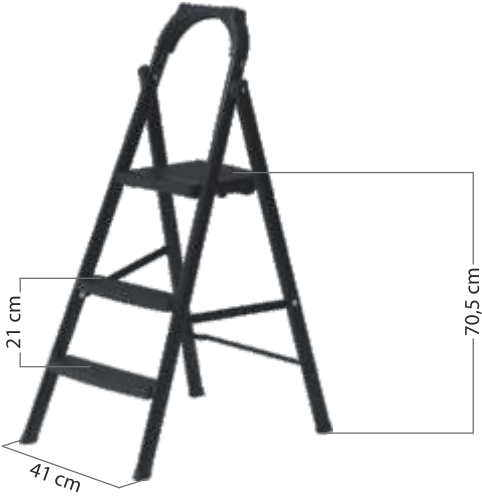

21003

4 - STEP

3+1

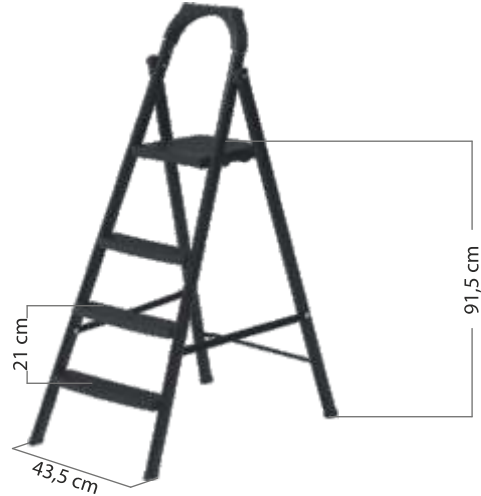

21004

5 - STEP

4+1

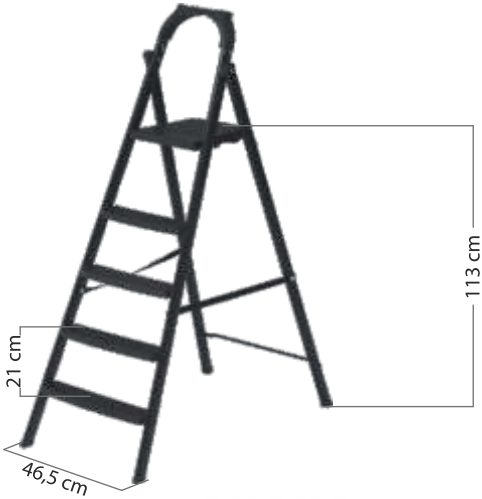

21005

6 - STEP

5+1

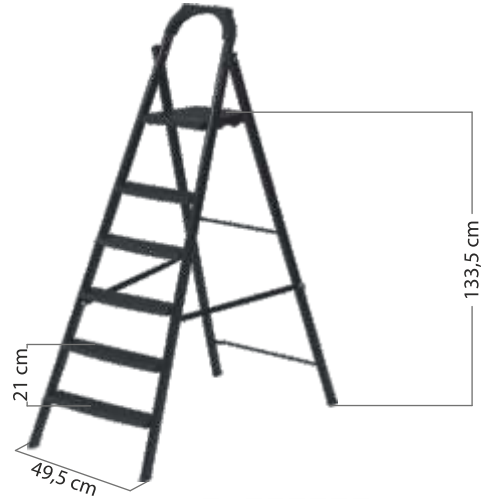

21006

7 - STEP

6+1

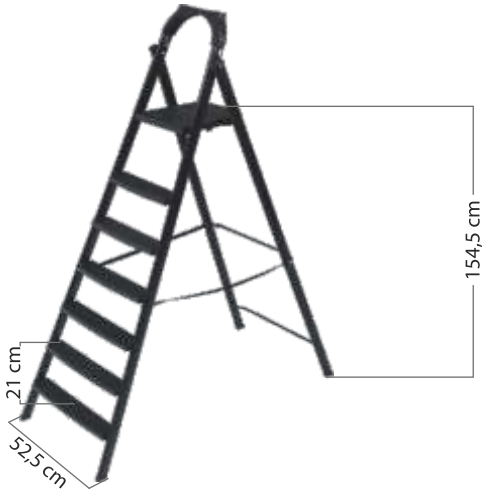

21007

8 - STEP

7+1

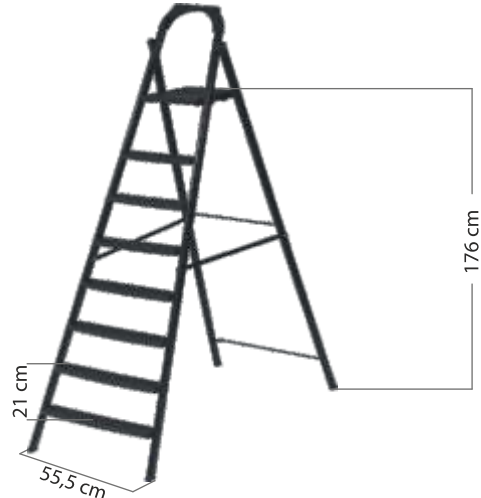

21008

### TECHNICAL INFORMATION

MODEL NAME	CODE	WEIGHT (± 0,50 Kg)	CBM (m <sup>3</sup> )	20 DC (33 m <sup>3</sup> ) (Pcs. - Adt.)	40 HQ (76 m <sup>3</sup> ) (Pcs. - Adt.)	TRUCK (90 m <sup>3</sup> ) (Pcs. - Adt.)
3 - Step / Basamak (2+1)	21003	3,80	0,044	750	1727	2045
4 - Step / Basamak (3+1)	21004	4,54	0,054	611	1407	1667
5 - Step / Basamak (4+1)	21005	5,31	0,065	508	1169	1385
6 - Step / Basamak (5+1)	21006	6,29	0,077	429	987	1169
7 - Step / Basamak (6+1)	21007	7,40	0,900	367	844	1000
8 - Step / Basamak (7+1)	21008	8,02	0,140	317	731	865

## CERTIFICATE of Conformity



Registration No.: AK 60171215 0001  
Report No.: DE23CRTV 004

Holder: Cakmak Ev Gereçleri San. ve Tic. Ltd. Şti.  
Mimarsinan Organize Sanayi Bölgesi 5. Cad. No 5  
38165 Melikgazi Kazseri  
Türkiye

Product: **Step stool**  
Folding step stools with plastic steps and platform (3 sizes)

Identification: Eurostep Model 182-001  
Number of steps: 2  
Eurostep Model 183-001  
Number of steps: 3  
Eurostep Model 184-001  
Number of steps: 4  
Dimensions see appendix 1

Tested acc. to: EN 14183:2003

The certificate of conformity refers to the above mentioned product. This is to certify that the specimen is in conformity with the assessment requirement mentioned above. This certificate does not imply assessment of the production of the product and does not permit the use of a TÜV Rheinland mark of conformity.

Certification Body



Date: 21.07.2023

TÜV Rheinland LGA Products GmbH - Tillystraße 2 - 90431 Nürnberg

TÜV Rheinland  
LGA Products GmbH  
Tillystraße 2, 90431 Nürnberg



Attachment to  
Registration No.: AK 60171215 0001  
Report No.: DE23CRTV 004

Manufacturer: Cakmak Ev Gereçleri San. ve Tic. Ltd. Şti.  
Mimarsinan Organize Sanayi Bölgesi 5. Cad. No 5  
38165 Melikgazi Kazseri  
Türkiye

Scope: Eurostep Model 182-001:  
Number of steps: 2  
Weight: 4,73 kg  
h = 465 mm / b2 = 466 mm / 546 mm / b6 = 489 mm / β = 83°  
Eurostep Model 183-001:  
Number of steps: 3  
Weight: 6,43 kg  
h = 697 mm / b2 = 466 mm / 544 mm / b6 = 641 mm / β = 80°  
Eurostep Model 184-001:  
Number of steps: 4  
Weight: 8,56 kg  
h = 927 mm / b2 = 493 mm / 570 mm / b6 = 829 mm / β = 78°  
For all: a = 231 mm / b1 = 368 mm / b3 = 368 mm b5 = 269 mm  
Stile: Ø: 25 x 0,95 mm (steel)

Certification Body

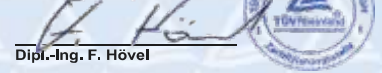

Date: 2023-07-21

Dipl.-Ing. F. Hövel



## UYGUNLUK ONAYI

2001/95/EC Genel Ürün Güvenliği Direktifi Yönetmeliği



Üretici Firma,

**CAKMAK EV GEREÇLERİ SANAYİ VE TİCARET LİMİTED ŞİRKETİ**

Mimarsinan Organize Sanayi 5.Cadde No:5 Melikgazi/KAYSERİ

Aşağıda tanımlanan ürünün teknik dokümanı ve tipik test raporları, 2001/95/EC Genel Ürün Güvenliği Direktifi Yönetmeliği kapsamında uygunluğu doğrulanmıştır. İş bu belge, incelenen yapılan ürün, ürüne ait teknik dokümanı ve raporları için geçerlidir. Ürün Tasarımının dağıtımına sunumuna bu belge geçerli olacaktır.

Ürün Tanımı

1 Tek veya Çift Taraflı Basamaklı Metal Merdiven

ANKA (3-4-5-6-7-8-9-10) BASAMAKLI METAL MERDİVEN,  
LEO (2-4-5-6-7-8) BASAMAKLI METAL MERDİVEN,  
ANKA PLUS (3-4-5-6-7-8-9) BASAMAKLI METAL MERDİVEN,  
MİNGA PLUS (2-4-5-6-7-8-9-10) BASAMAKLI METAL MERDİVEN,  
LEPUS (2-2, 3-3, 4-4, 5-5, 6-6, 7-7) BASAMAKLI METAL MERDİVEN,  
LEPUS PLUS (2-2, 3-3, 4-4, 5-5, 6-6, 7-7) BASAMAKLI METAL MERDİVEN,  
LEO PLUS (3-4-5-6-7-8) BASAMAKLI METAL MERDİVEN,  
EUROTOWER (1-2-3-4-5) BASAMAKLI MERDİVEN (ÇOKLU),  
EUROTOWER (1-2-3-4-5) BASAMAKLI MERDİVEN (TEKİL),  
MINTOWER (2-3-4) BASAMAKLI METAL MERDİVEN (ÇOKLU),  
VERA (3-4-5-6-7-8) BASAMAKLI METAL MERDİVEN,  
VERA PLUS (3-4-5-6-7-8) BASAMAKLI METAL MERDİVEN

Ürünün Ticari Markası

1 ÇAKMAK - EUROSTEP

Uygulanabilir AT Direktifleri

1 2001/95/EC Genel Ürün Güvenliği Direktifi Yönetmeliği

Harmonize Standartlar

1 TS EN 131-1, TS EN 131-2, TS EN 14183

İlk Yayın Tarihi: 26.01.2022  
Belge Tarihi: 17.01.2024  
Bilgi Tarihi: 25.01.2025  
Sertifika No: CE-2024-2266

Ascort Certification  
Sertifika Orayı



## ATTESTATION OF COMPLIANCE

2001/95/EC General Product Safety Directive



We hereby declare, Manufacturer, Distributor/ EU Representative:

**CAKMAK EV GEREÇLERİ SANAYİ VE TİCARET LİMİTED ŞİRKETİ**

Mimarsinan Organize Sanayi 5.Cadde No:5 Melikgazi, Kayseri, TURKEY

that the following described product is our delivered version complies with appropriate latest safety and health requirements of the 2001/95/EC General Product Safety Directive based on its design and type, as brought into circulation by us. In Case of the alteration of the product, not agreed upon by us, this declaration will lose its validity.

Description of the Product

1 Single or Double Sided Metal Step Ladder

ANKA (3-4-5-6-7-8-9-10) METAL STEP LADDER,  
LEO (2-4-5-6-7-8) METAL STEP LADDER,  
ANKA PLUS (3-4-5-6-7-8-9) METAL STEP LADDER,  
MİNGA PLUS (2-4-5-6-7-8-9-10) METAL STEP LADDER,  
LEPUS (2-2, 3-3, 4-4, 5-5, 6-6, 7-7) METAL STEP LADDER,  
LEPUS PLUS (2-2, 3-3, 4-4, 5-5, 6-6, 7-7) METAL STEP LADDER,  
LEO PLUS (3-4-5-6-7-8) METAL STEP LADDER,  
EUROTOWER (1-2-3-4-5) METAL STEP STOOL LADDER (MULTI),  
EUROTOWER (1-2-3-4-5) METAL STEP STOOL LADDER (SINGLE),  
MINTOWER (2-3-4) METAL STEP STOOL LADDER (MULTI),  
VERA (3-4-5-6-7-8) METAL STEP LADDER,  
VERA PLUS (3-4-5-6-7-8) METAL STEP LADDER,

Type

Product Commercial Brand

1 ÇAKMAK - EUROSTEP

Applicable EC Directives

1 2001/95/EC General Product Safety Directive

Applicable Harmonized Standards

1 TS EN 131-1, TS EN 131-2, TS EN 14183

Issue date: 26.01.2022  
Valid from: 17.01.2024  
Valid till: 25.01.2025  
Certificate Number: CE-2024-2266

Ascort Certification  
System Certificate Approved







# SERTİFİKA CERTIFICATE

**ÇAKMAK EV GEREÇLERİ SANAYİ VE TİCARET  
LİMİTED ŞİRKETİ**

MİHARŞINAN ORGANİZE SANAYİ 5. CADDE NO:5 MELİKGAZI, KAYSERİ, TÜRKİYE

TEK VEYA ÇİFT TARAFLI BASAMAKLI METAL MERDİVEN, YERSİL VE VİDALI MOP SAPI  
ÜRETİMİ, SATIŞI, İTHALATI VE İHRACATI

PRODUCTION, SALES, IMPORT AND EXPORT OF SINGLE OR DOUBLE SIDED METAL  
STEP LADDER, METAL SQUEEGEE AND METAL MOP HANDLE

IAF/EA Kod(Code): 17

## ISO 9001:2015

Kalite Yönetim Sistemi Standardının şartlarına uygun bir yönetim sistemi kurduğunu ve uyguladığını  
onaylamak üzere verilmiştir.  
To certify that quality management system in accordance with standard's clauses is established and being  
implemented.

İlk Yayın Tarihi / Date of first issue : 26.01.2022  
Belge Tarihi / Date of issue : 17.01.2024  
Belge Periyodu / Certificate period : 3 Yıl  
Sertifika Bitiş Tarihi / Release date : 25.01.2025  
Sertifika No / Certificate Number : KQ.2022.2267



MSCB-223

Ascort Certification  
Sertifika Onayı / System Certificate Approved

ASCORT BELGELENDİRME VE EĞİTİM HİZMETLERİ LİMİTED ŞİRKETİ  
Nispetiye Mahallesi 1123 Sokak No:21 Kat:1 Mecidiyeköy 34092 İstanbul/TÜRKİYE  
Tic. Sic. No: 27 228 111 - E-Posta: info@ascort.com.tr

No certificate granted/ www.ascort.com.tr - information further available. (Validity of this certificate can be checked at www.ascort.com.tr)



# SERTİFİKA CERTIFICATE

**ÇAKMAK EV GEREÇLERİ SANAYİ VE TİCARET  
LİMİTED ŞİRKETİ**

MİHARŞINAN ORGANİZE SANAYİ 5. CADDE NO:5 MELİKGAZI, KAYSERİ, TÜRKİYE

TEK VEYA ÇİFT TARAFLI BASAMAKLI METAL MERDİVEN, YERSİL VE VİDALI MOP SAPI  
ÜRETİMİ, SATIŞI, İTHALATI VE İHRACATI

PRODUCTION, SALES, IMPORT AND EXPORT OF SINGLE OR DOUBLE SIDED METAL  
STEP LADDER, METAL SQUEEGEE AND METAL MOP HANDLE

IAF/EA Kod(Code): 17

## ISO 14001:2015

Çevre Yönetim Sistemi Standardının şartlarına uygun bir yönetim sistemi kurduğunu ve uyguladığını  
onaylamak üzere verilmiştir.  
To certify that environmental management system in accordance with standard's clauses is established and  
being implemented.

İlk Yayın Tarihi / Date of first issue : 26.01.2022  
Belge Tarihi / Date of issue : 17.01.2024  
Belge Periyodu / Certificate period : 3 Yıl  
Sertifika Bitiş Tarihi / Release date : 25.01.2025  
Sertifika No / Certificate Number : CE.2022.2267



MSCB-223

Ascort Certification  
Sertifika Onayı / System Certificate Approved

ASCORT BELGELENDİRME VE EĞİTİM HİZMETLERİ LİMİTED ŞİRKETİ  
Nispetiye Mahallesi 1123 Sokak No:21 Kat:1 Mecidiyeköy 34092 İstanbul/TÜRKİYE  
Tic. Sic. No: 27 228 111 - E-Posta: info@ascort.com.tr

No certificate granted/ www.ascort.com.tr - information further available. (Validity of this certificate can be checked at www.ascort.com.tr)



# SERTİFİKA CERTIFICATE

**ÇAKMAK EV GEREÇLERİ SANAYİ VE TİCARET  
LİMİTED ŞİRKETİ**

MİHARŞINAN ORGANİZE SANAYİ 5. CADDE NO:5 MELİKGAZI, KAYSERİ, TÜRKİYE

TEK VEYA ÇİFT TARAFLI BASAMAKLI METAL MERDİVEN, YERSİL VE VİDALI MOP SAPI  
ÜRETİMİ, SATIŞI, İTHALATI VE İHRACATI

PRODUCTION, SALES, IMPORT AND EXPORT OF SINGLE OR DOUBLE SIDED METAL  
STEP LADDER, METAL SQUEEGEE AND METAL MOP HANDLE

## ISO 45001:2018

İş Sağlığı ve Güvenliği Yönetim Sistemi Standardının şartlarına uygun bir yönetim sistemi kurduğunu  
ve uyguladığını onaylamak üzere verilmiştir.  
To certify that Occupational Health and Safety Management System in accordance with standard's clauses is  
established and being implemented.

İlk Yayın Tarihi / Date of first issue : 26.01.2022  
Belge Tarihi / Date of issue : 17.01.2024  
Belge Periyodu / Certificate period : 3 Yıl  
Sertifika Bitiş Tarihi / Release date : 25.01.2025  
Sertifika No / Certificate Number : SO.2022.2267



Ascort Certification  
Sertifika Onayı / System Certificate Approved

ASCORT BELGELENDİRME VE EĞİTİM HİZMETLERİ LİMİTED ŞİRKETİ  
Nispetiye Mahallesi 1123 Sokak No:21 Kat:1 Mecidiyeköy 34092 İstanbul/TÜRKİYE  
Tic. Sic. No: 27 228 111 - E-Posta: info@ascort.com.tr

No certificate granted/ www.ascort.com.tr - information further available. (Validity of this certificate can be checked at www.ascort.com.tr)



# SERTİFİKA CERTIFICATE

**ÇAKMAK EV GEREÇLERİ SANAYİ VE TİCARET  
LİMİTED ŞİRKETİ**

MİHARŞINAN ORGANİZE SANAYİ 5. CADDE NO:5 MELİKGAZI, KAYSERİ, TÜRKİYE

TEK VEYA ÇİFT TARAFLI BASAMAKLI METAL MERDİVEN, YERSİL VE VİDALI MOP SAPI  
ÜRETİMİ, SATIŞI, İTHALATI VE İHRACATI

PRODUCTION, SALES, IMPORT AND EXPORT OF SINGLE OR DOUBLE SIDED METAL  
STEP LADDER, METAL SQUEEGEE AND METAL MOP HANDLE

## ISO 10002:2018

Müşteri Memnuniyeti ve Şikayetleri Yönetim Sistemi Standardının şartlarına uygun bir sistem  
kurduğunu ve uyguladığını onaylamak üzere verilmiştir.  
To certify that customer satisfaction management system in accordance with standard's clauses is established  
and being implemented.

İlk Yayın Tarihi / Date of first issue : 26.01.2022  
Belge Tarihi / Date of issue : 17.01.2024  
Belge Periyodu / Certificate period : 3 Yıl  
Sertifika Bitiş Tarihi / Release date : 25.01.2025  
Sertifika No / Certificate Number : MC.2022.2267



Ascort Certification  
Sertifika Onayı / System Certificate Approved

ASCORT BELGELENDİRME VE EĞİTİM HİZMETLERİ LİMİTED ŞİRKETİ  
Nispetiye Mahallesi 1123 Sokak No:21 Kat:1 Mecidiyeköy 34092 İstanbul/TÜRKİYE  
Tic. Sic. No: 27 228 111 - E-Posta: info@ascort.com.tr

No certificate granted/ www.ascort.com.tr - information further available. (Validity of this certificate can be checked at www.ascort.com.tr)

# EUROSTEP

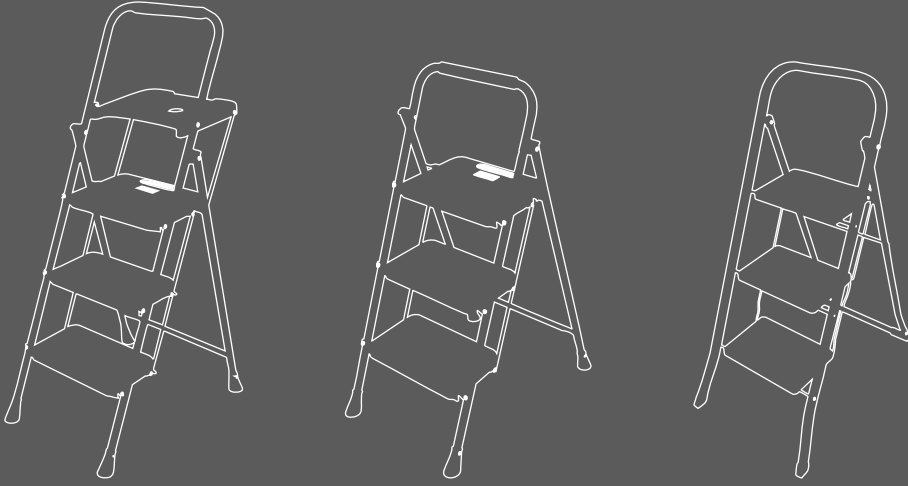
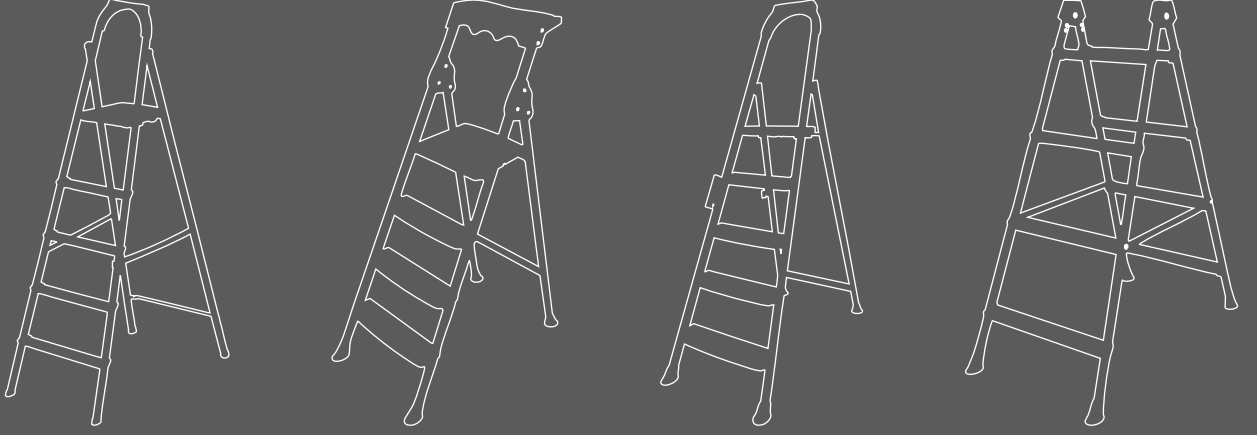

**ÇAKMAK**

EV GEREÇLERİ SANAYİ VE TİCARET LTD. ŞTİ.

## FABRİKA / FACTORY

ÇAKMAK EV GEREÇLERİ SAN. VE TİC. LTD. ŞTİ.

Mimarsinan Organize Sanayi Bölgesi, 5. Cadde, No: 5, Melikgazi - Kayseri - TÜRKİYE

+90 (352) 321 40 90 / +90 (534) 593 24 73

export@cakmakmetal.com

[www.cakmakmetal.com](http://www.cakmakmetal.com)